



Remote Node Installation Guide

vIG_RN_2022-04



Table of Contents

TABLE OF CONTENTS	1
SAFETY AND WARNINGS	2
GENERAL WARNINGS	2
FCC INFORMATION	2
GENERAL HEALTH AND SAFETY INFORMATION	3
HEALTH AND SAFETY WARNING	4
WARNING LABELS	4
GENERAL HAZARDS	5
PREPARATION	6
TOOLS	6
CUSTOMER SUPPLIED EQUIPMENT	6
TARANA HARDWARE AND PERIPHERALS	7
PHYSICAL INSTALLATION	8
MOUNTING	8
RN CHASSIS BRACKET ASSEMBLY	8
ELEVATION BRACKET INSTALLATION	9
ANTENNA AIMING	11
GROUNDING AND POWERING THE RN	12
LOGGING INTO THE RN	15
RN SETUP	16
VERIFY CONNECTIVITY	16
RADIO STATE AND ALIGNMENT METRIC	17
HOSTNAME AND DATA VLAN	18
GEOGRAPHY AND ORIENTATION PARAMETERS	19

TCS CONFIRMATION	21
CBRS STEPS IN TCS	22
SUPPLIER'S DECLARATION OF CONFORMITY	23
SUPPLIER'S DECLARATION OF CONFORMITY	24
REGULATORY INFORMATION	25
DEPLOYMENT IN THE US — FCC STATEMENT	25
DEPLOYMENT IN CANADA — INDUSTRY CANADA STATEMENTS	26
RESOLUTION 680: BRAZIL	27
USA CBRS BAND CATEGORY B DEVICE	27
WARRANTY	28

Note: Please download the latest version of this document at:

www.taranawireless.com/rn_manual

For other documentation and videos, see our customer portal at:

<https://private.taranawireless.com/>

Safety and Warnings

Tarana G1 equipment is designed for installation and use by trained professionals and requires adherence to all relevant regulatory, safety, and telecom industry best practice guidelines for outdoor radios.

General Warnings

Failure to observe these safety precautions may result in personal injury or damage to equipment.

- Follow all warnings and instructions marked on this product.
- Use standard safety guidelines when mounting. Installation and maintenance procedures must be followed and performed by trained personnel only.
- Before unmounting the product, disconnect power input to reduce the risk of hazards.
- Only use Tarana-approved Power over Ethernet (PoE) injectors.
- Do not open the device. Opening the device voids the warranty.
- Do not stack anything on the radome.
- Cable ends must be protected from weather if not connected to the device.

FCC Information

The FCC occupational controlled limit for maximum permissible exposure (MPE) is 5 mW/cm². It is estimated that the maximum power density at the radome is 1.25 mW/cm², which is below the FCC MPE limit. Since the power density for an occupational controlled environment is less than the FCC limit, no additional precautions are necessary. The occupational uncontrolled environment limit for maximum permissible exposure (MPE) is 1 mW/cm². To meet this MPE requirement, the operator must be at a distance of 24.8 in or 63 cm away from the radome cover of the system.

General Health and Safety Information

Topic	Explanation
Flammability	The equipment is designed and constructed to minimize the risk of smoke and fumes during a fire.
Hazardous Materials	No hazardous materials are used in the construction of this equipment.
Hazardous Voltage	The G1 system meets global product safety requirements for safety extra-low voltage (SELV) rated equipment.
Safety Signs	External warning signs or other indicators on the equipment are not required.
Surface Temperatures	The external equipment surfaces become warm during operation, due to heat dissipation. However, the temperatures reached are not considered hazardous.

Health and Safety Warning

All personnel must comply with the relevant health and safety practices when working on or around the G1 radio equipment.

The G1 system has been designed to meet relevant US and European health and safety standards as outlined in IEC Publication 62368-1, 2nd edition.

Local safety regulations must be used if required. Safety instructions in this section should be used in addition to the local safety regulations. In the case of conflict between safety instructions stated herein and those indicated in local regulations, mandatory local norms will prevail. Should local regulations not be mandatory, then safety norms herein will prevail.

Warning Labels

WARRANTY VOID

DO NOT BREAK THE TAMPER SEALS ON HARDWARE. DOING SO WILL VOID THE WARRANTY.

WARNING

Making adjustments and/or modifications to this equipment that are not in accordance with the provisions of this User Guide, the Installation Guide or other supplementary documentation may result in personal injury or damage to the equipment, and may void the equipment warranty.

AVERTISSEMENT

Tout réglage ou modification faits à cet équipement hors du cadre édicté par ce guide d'utilisation ou par toute autre documentation supplémentaire pourraient causer des blessures ou endommager l'équipement et peut entraîner l'annulation de sa garantie.

WARNUNG

Die an diesen Geräten gemachte Einstellungen und/oder Änderungen, welche nicht gemäß dieser Bedienungsanleitung, oder gemäß anderen zusätzlichen Anleitungen, ausgeführt werden, können Verletzungen oder Materialschäden zur Folge haben und eventuell die Garantie ungültig machen.

ATENCIÓN

Llevar a cabo ajustamientos y/o modificaciones a este equipo, sin seguir las instrucciones provistas por este manual u otro documento adicional, podría resultar en lesiones a su persona o daños al equipo, y anular la garantía de este último.

警告

對本设备进行不符合本用户指南, 安装手册, 或其他补充文件规定的调整和/或修改可能会导致人身伤害或设备损坏, 并可能导致失去设备的保修。

General Hazards

Topic	Explanation
Protection from RF Exposure	<p>When installing, servicing or inspecting an antenna always comply with the following:</p> <ul style="list-style-type: none">• Locate the antenna such that it does not infringe the RF Exposure Limit Distance, relating to the Compliance Boundary General Public.• Stay aware of the potential risk of RF exposure and take appropriate precautions.• Do not stand in front of or look into an antenna without first ensuring the associated transmitter or transmitters are switched off.• At a multi-antenna site ask the site owner or operator for details of other radio services active at the site and for their requirements/recommendations for protection against potentially harmful exposure to RF radiation.• When it is not possible to switch transmitters off at a multi-antenna site and there is potential for exposure to harmful levels of RF radiation, wear a protective suit.
Grounding Connections	Reliable grounding of the RN chassis must be maintained.
Power Supply	The RN must be powered by a Tarana provided Power over Ethernet (PoE) injector.
Maximum Ambient Temperature	The maximum ambient temperature for the RN product is 55 degrees C. To ensure correct operation and to maximize long term component reliability, ambient temperatures must not be exceeded. Operational specification compliance is not guaranteed for higher ambients. The RN should be mounted in such a way as to permit the vertical free flow of air through its cooling fins.
Rack Mount Temperature Considerations	The RN is designed to operate in an outdoor environment with no significant obstructions in front of the radome. Do not install the RN in a closed or multi-unit rack assembly, because such a closed rack would impede the propagation of the RF signals. The maximum ambient temperature applies to the immediate operating environment of the RN product.

Preparation

Use the following checklists to ensure you have all the required items before beginning a Tarana RN installation. Verify the contents of the Tarana supplied hardware.

Tools

- #2 Phillips tip screwdriver
- 8mm hex socket wrench
- Torque wrench
- Crimping tool (not shown)
- Laptop with admin rights (not shown)



Figure 1: Tools

Customer Supplied Equipment

- Grounding wire per local electrical code with attachment tapped for an M5 screw
- Ethernet cable - shielded CAT5e/CAT6, outdoor-rated
- Ethernet cable - shielded CAT5e/CAT6, indoor-rated
- Note: The total length of both Ethernet cables must not exceed 100m (328 ft).



Figure 2: Customer Supplied Equipment

Tarana Hardware and Peripherals

- PoE injector 40-60 VDC, 1.5A
- (2) Worm gear clamps
- Grounding screw
- Ethernet cable cord grip
- (8) M5 flanged-head screw with thread lock
- RN chassis bracket
- RN elevation bracket
- Tarana G1 Remote Node (RN) radio unit

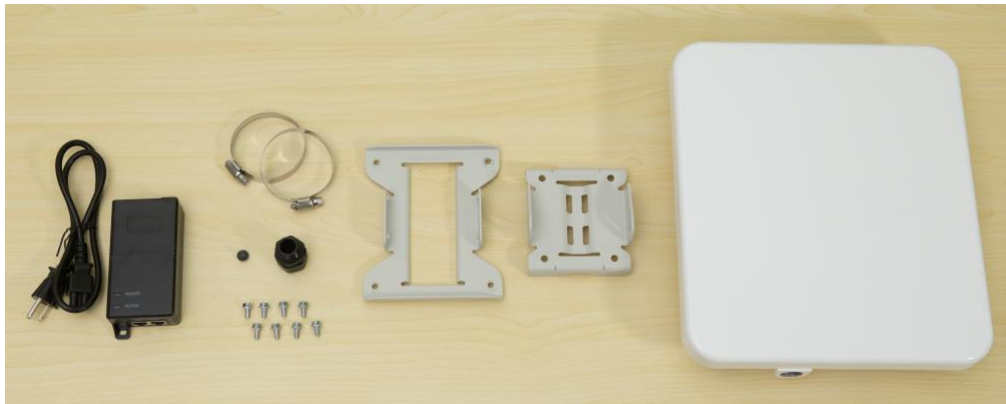

Figure 3: Tarana Hardware

Physical Installation

Mounting

RN Chassis Bracket Assembly

The chassis bracket is attached directly to the RN unit prior to mounting on the elevation bracket.

Step 1. Align the screw holes of the chassis bracket with the 4 threaded holes on the back of the RN.

Step 2. Using an 8mm hex socket wrench, install the four screws.

Step 3. With the bracket in the final position, torque 4 bolts with incremental steps at approximately 40%, 70%, and 100% of full torque rating:

- Following the torque sequence 1-2-3-4 shown below, torque all bolts to values of approximately 40% (2.4 N-m or 1.7 lb-ft).
- Continue with the same sequence for all bolts at approximately 70% (4.2 N-m or 3 lb-ft).
- Repeat the torque sequence for all bolts until each bolt is stabilized at 6 N-m (4.4 lb-ft).

Step 4. Partially install one screw on each elevation attachment tab on the chassis bracket in the locations closest to the top of the RN unit. The two screws should be screwed into the tabs enough that about 2 threads are exposed coming out of the backside of each tab.

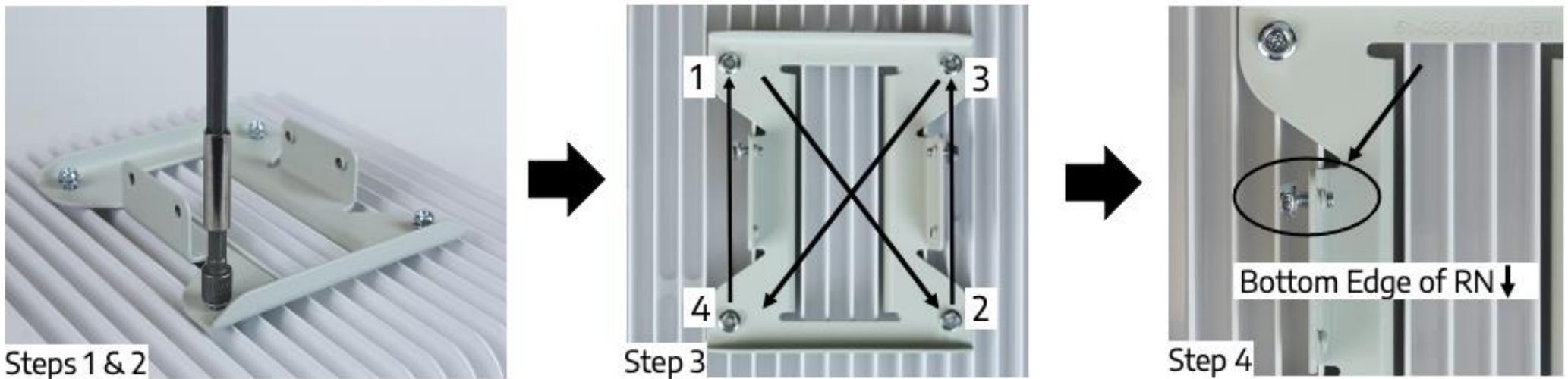

Figure 4: Attaching the Chassis Bracket

Elevation Bracket Installation

The elevation bracket may be attached to a pole or wall.

Pole Mount Installation

The elevation bracket may be installed on poles that are a minimum of 38 mm (1.40 in) to a maximum of 64 mm (2.40 in) outside diameter.

Step 1. Route the opened worm gear clamps through the bracket. The serrated surfaces of the bracket will be facing the pole and the clamps will go around the pole.

Step 2. Mount the bracket such that the elevation tabs are protruding away from the pole. The vertical hanger slots should be on top and the horizontal elevation slots should be on the bottom.

The band clamps should be torqued to 4.5 – 5.1 N-m (3.3–3.7 lb-ft). Do not exceed torque range.

Step 3. Lower the partially-installed screws on the chassis bracket mounted to the RN into the vertical hanger slots.

Step 4. With the RN in place on the elevation bracket, tighten all 4 screws between the chassis bracket and the elevation bracket.

Tilt adjustment may be made from 20 degrees up to 5 degrees down.

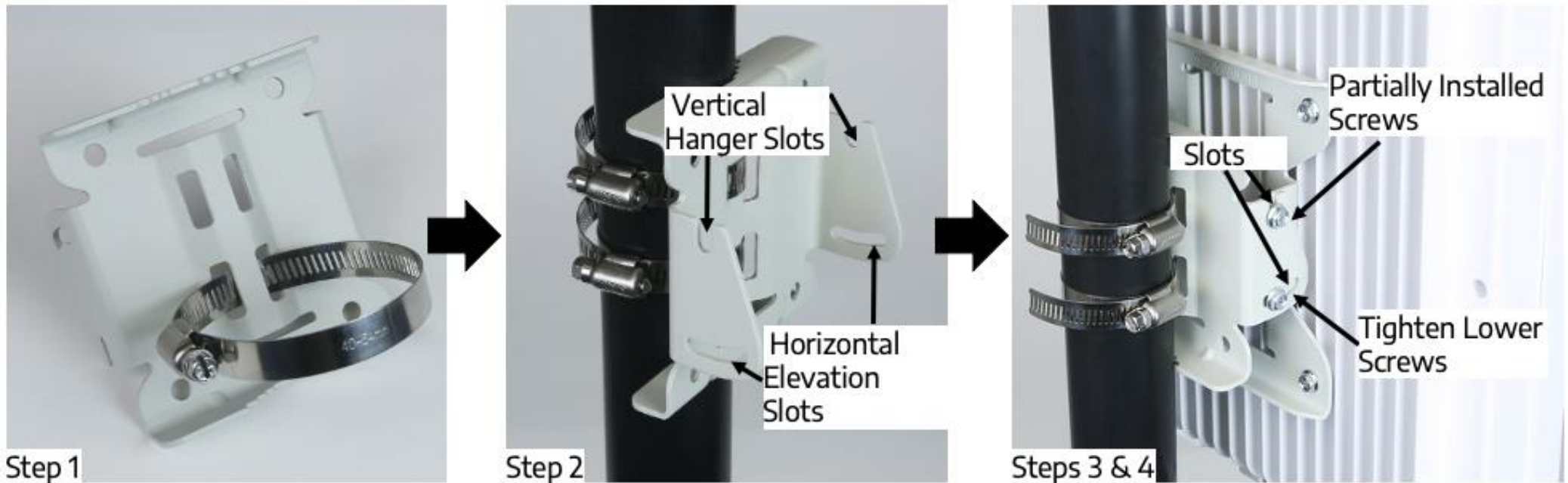

Figure 5: Elevation Bracket Installation (Pole Mount)

Wall Mounting Installation

If a pole mount is not desired, the elevation bracket may be attached to a wall. Use fasteners appropriate to the wall material. A load rating of 23 kg (50 lbs) is recommended per fastener.

Step 1. With the elevation tabs protruding away from the wall as shown, apply fasteners at the corners of the bracket to attach to a flush surface (wall). Do not modify or enlarge the screw holes as this will compromise the corrosion protection of the finish.

Step 2. Lower the partially-installed screws on the chassis bracket mounted to the RN into the slots of the elevation tabs.

Step 3. With the RN in place on the elevation bracket, tighten both the partially-installed screws and the lower screws connecting the chassis bracket to the elevation bracket.

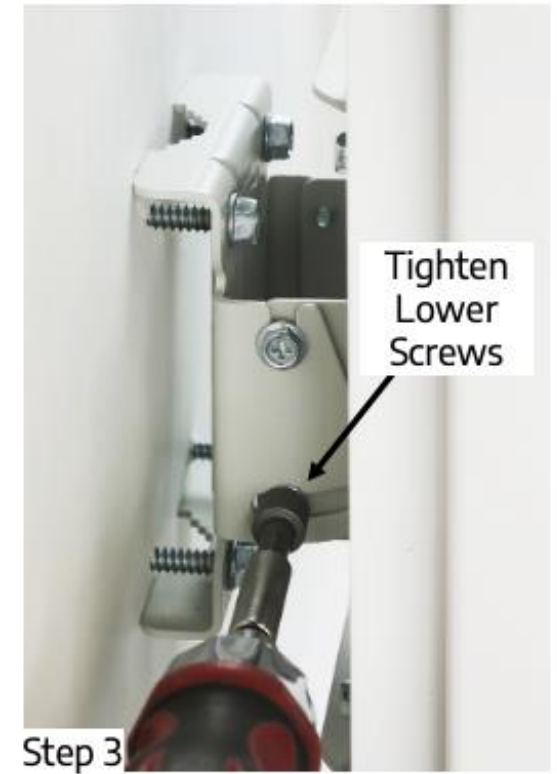
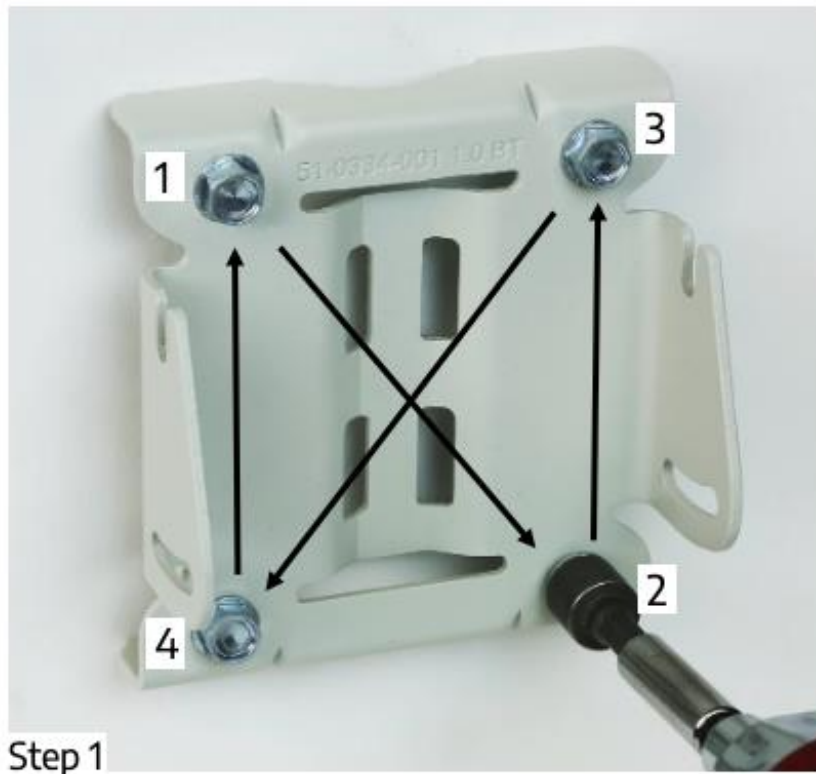

Figure 6: Elevation Bracket Installation (Wall Mount)

Antenna Aiming

It is necessary to ensure the RN is aimed in the direction of the BN. If unsure what direction the BN is relative to the RN, a satellite view of the deployment area can assist in determining the proper direction in which to aim the RN. Antenna alignment will be verified in the final step via the web UI.



Figure 7: Aiming the RN

Grounding and Powering the RN

The RN should be grounded and powered in accordance with local electrical codes and ordinances. Consult your local regulations to ensure compliance as part of this step. Proper grounding is critical to ensure the unit is protected from hazards such as lightning.

- Step 1. Begin the process by attaching the ground system to the RN chassis.. Attach a ground wire with the pre-installed M5 screw that is on the RN as indicated. A ring terminal suitable for the M5 screw should be crimped to the ground wire.



- Step 2. Torque the screw to 6 N-m (4.5 lb-ft). The grounding wire should not limit the adjustment of the antenna.

- Step 3. Remove the nut from the cord grip body and then push out the grommet.

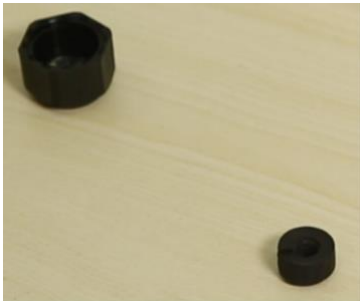

- Step 4. Thread the Ethernet cable through the nut and then thread the cable through the cord grip body.



- Step 5. Insert the cable into the RN Ethernet port and screw the cord grip body into the RN, taking care to not cross thread the plastic threads of the cord grip body with the aluminum threads of the RN enclosure.



Step 6. Torque the body of the cord grip to 4.5–5.1 N-m (3.3–3.8 lb-ft).

Step 7. Insert the grommet into the cord grip body chamfered end first. Then screw the sealing nut onto the body and torque the sealing nut to 5.6–6.2 N-m (4.1- 4.6 lb-ft).



Properly terminate and test the Ethernet cable run before proceeding. This should include power verification on all pins of the Ethernet cable using a PoE tester.

Step 8. Power Up the RN

Upon receiving power, the RN will undergo the power up process.

There are 3 LEDs on the bottom edge of the RN that will cycle through patterns and colors during this time.

Ensure the PoE injector is protected from the elements in a suitable enclosure or installed indoors.

The total length of both Ethernet cables (CAT5e or higher) from the customer's access point or switch to the PoE injector and from the PoE injector to the RN must not exceed 100 m (328 feet).

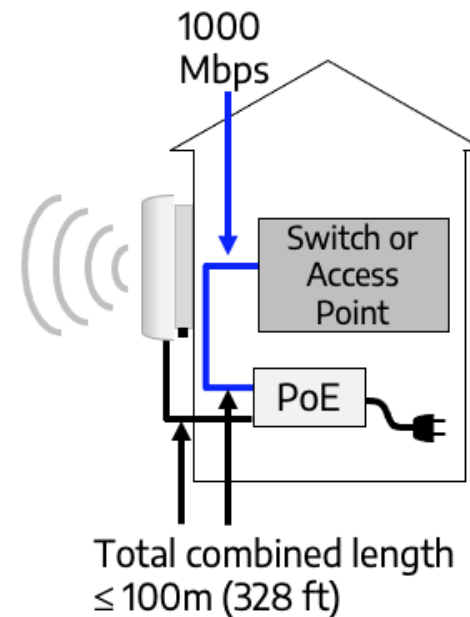

Additional local electrical codes and ordinances may apply to grounding. Compliance in this area is the responsibility of the installation company.

The PoE injector must be connected to a Gigabit Ethernet device (laptop, router, switch, or access point) in order to function correctly. Other speeds (10/100 Mbps) are not supported.

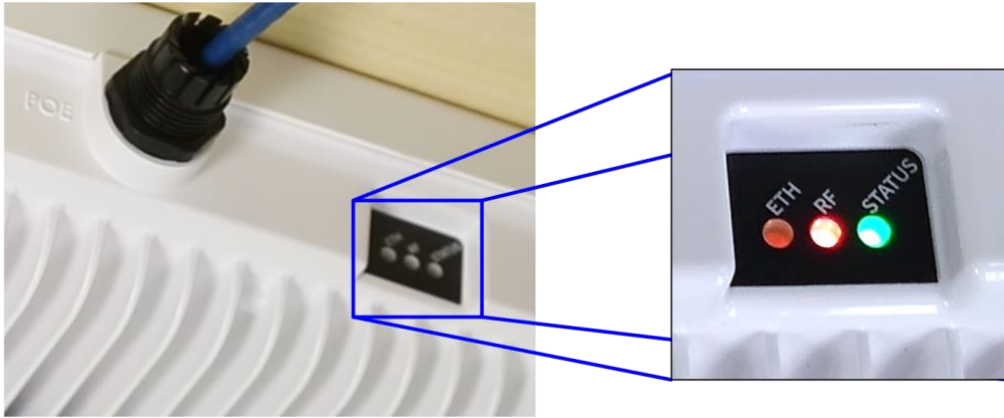



At the end of this period, the LEDs will settle into one of a few common states as described below.

LED INDICATOR	LED BEHAVIOR	DESCRIPTION
ETH		The Ethernet port on the RN has a data connection. The LED blinks as data is being transmitted across the line.
RF		The LED is a solid green, which indicates the RN has established an RF link to the BN.
STATUS		The LED is a solid green indicating that the RN has booted successfully.

Logging into the RN

To verify installation, log into the RN. This is done via the RN web management interface.

Step 1. To log into the management interface, connect a laptop with a 1000 Mbps Ethernet port to the Ethernet port of the PoE powering the RN.

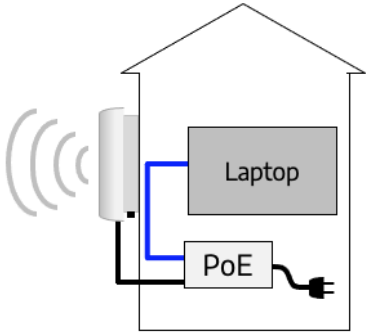

Step 2. Assign a static IP address of 192.168.10.10 to the laptop's Ethernet port.

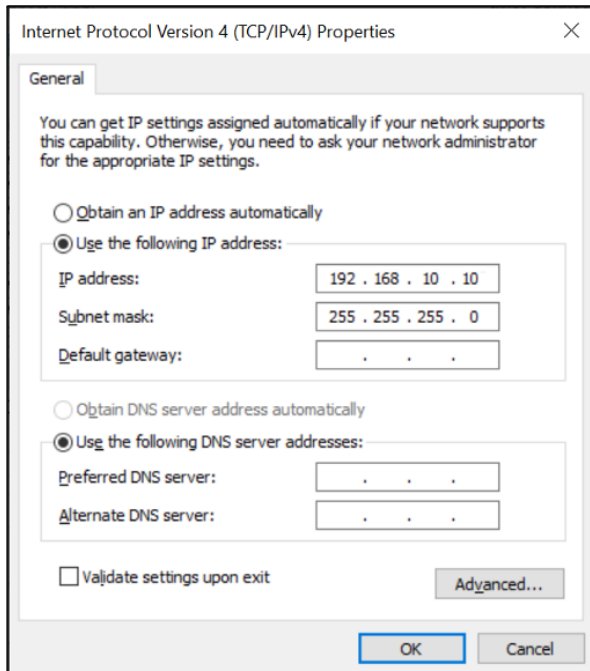

Step 3. Open a browser and type “192.168.10.2” into the URL bar to access the RN’s web interface.

Step 4. Enter the username “**admin**” and password “**admin123**” when prompted for credentials and click Login. This will bring up the RN’s management interface.



RN Setup

Verify Connectivity

In the management interface, verify the RN is connected to Tarana Cloud Suite (TCS) by confirming that the hostname of the RN at the top of the screen is in green text.

If the BN Operator ID was changed from the default of 0, edit the Operator ID on this page of the RN Web UI to match. **Note:** An RN will only connect to BNs with the same Operator ID.

Clicking Search for BNs will cause the RN to disconnect and search for a new BN. **Note:** Clicking Search for BNs will disconnect this RN and interrupt subscriber service.

The screenshot displays the Tarana RN Setup web interface. At the top right, the Hostname is shown as S154F1212600023 in green text, indicating a successful connection. The main content area is titled 'Setup' and includes a 'Search for BNs' button. Below this, the 'Operator ID' is set to 82. The 'Radio State' is 'UP' and the 'BN Serial' is S141T1212900202. The 'Alignment Metric' is shown as a green arc with the value 28.0 and a maximum of 28.3. On the right side, there are input fields for Hostname, Data VLAN, Latitude, Longitude, Tilt, Height, and Azimuth. A 'SUBMIT CHANGES' button is located at the bottom right. At the bottom, there is a 'BN Connection History' table.

BN Serial	Last Connect Time	Last Disconnect Time	Last Disconnect Reason
S141T1212900202	an hour ago	an hour ago	radio-reset

Figure 8: Verify Connectivity

Radio State and Alignment Metric

Verify the Radio State is UP. This parameter indicates whether the radio is searching, initializing, calibrating or up.

Before an RN connects to a BN, it will undergo a process of searching for a viable BN signal. The list of detected BN signals will be represented by the Search Metric as the RN scans through the supported frequencies. After the RN completes the scanning process, it will enter the Initialization stage with the BN that has the highest Search Metric. The RN will then go through the Calibration stage before the connection to the BN is established. This entire process can be repeated by clicking “Search for BNs”.

Once the RN is connected to a BN, the Alignment Metric will appear.

Note: It is important not to move the RN while it is in the Calibration stage.

The alignment metric can also be verified here. The alignment metric is a unitless dial that ranges from 0 to 30 with 30 being best. A minimum value of 12 is recommended for a usable link. Multiple factors are used to derive the alignment metric value. Once as the RN is aimed, the dial responds in real time and may be used as part of antenna aiming during installation.

The screenshot shows the TARANA Setup interface. On the left is a navigation menu with options: Dashboard, Interfaces, Setup (highlighted), Diagnostics, Upgrade, Reboot, and Snapshot. Below the menu is system information: January 17, 2022 2:04 PM, System Uptime an hour, Serial No S154F1212600023, and SYS.A3.R10.XXX.0.974.034.00. A Logout button is at the bottom. The main content area is titled 'Setup' and shows the following fields: Operator ID 82, Search for BNs button, Radio State UP (highlighted with a red box), BN Serial S141T1212900202, Alignment Metric 28.0 (with a gauge and 'max: 28.3' highlighted by a red box), Hostname S154F1212600023, Data VLAN 0, Latitude 39.560001373291016, Longitude -98.56300354003906, Tilt 0.1120000034570694, Height 0 m, and Azimuth 41.12799835205078. A SUBMIT CHANGES button is at the bottom right. Below this is a 'BN Connection History' table:

BN Serial	Last Connect Time	Last Disconnect Time	Last Disconnect Reason
S141T1212900202	an hour ago	an hour ago	radio-reset

Figure 9: Radio State and Alignment Metric

Hostname and Data VLAN

The BN Serial field displays the serial number of the BN to which the RN is connected.

The Hostname field shows RN hostname. By default, the serial number is used.

Optionally, the RN's Data VLAN can be set. Remember that this VLAN is between the RN and the BNG. **The optional VLAN setting on the RN overrides the VLAN setting on the BN (the RN does *not* tag or untag frames).** In this case, arriving frames sent from the network router to the BN's data port *must* be tagged with the VLAN number of the RN's setting. For more information about using VLANs in a G1 network, see the [G1 Administrator's Guide](#).

Note: Both hostname and data VLAN parameters can also be set or edited from TCS.

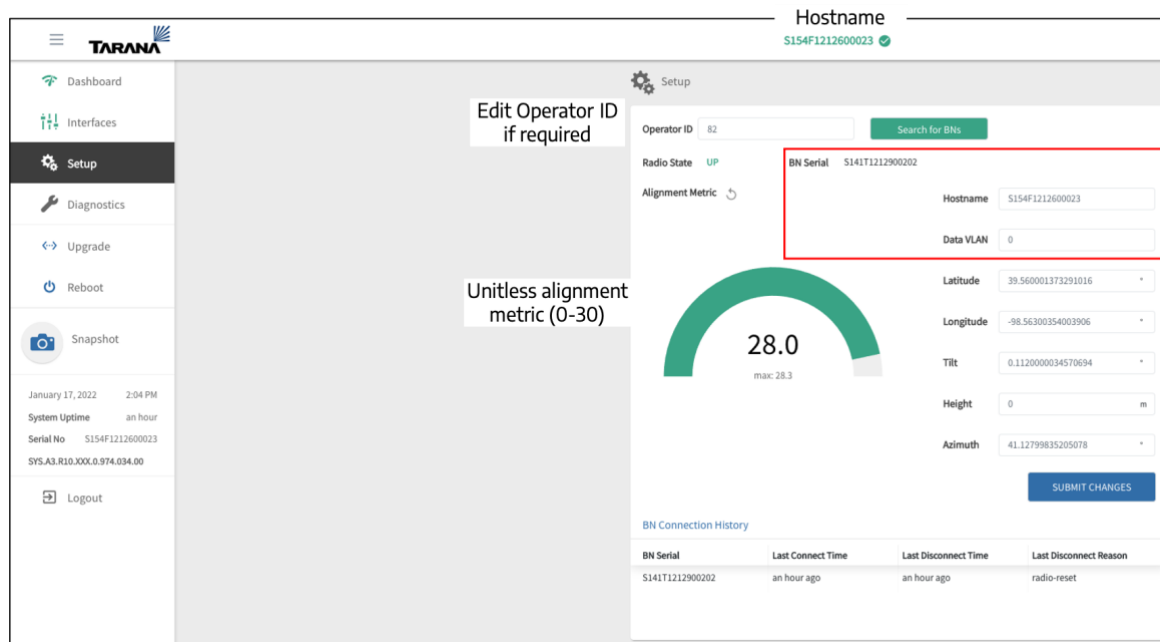

The screenshot shows the Tarana web interface for configuring a radio node. The page title is "Hostname" and the current node is identified by the serial number "S154F1212600023". The interface includes a sidebar with navigation options like Dashboard, Interfaces, Setup, Diagnostics, Upgrade, Reboot, and Snapshot. The main content area is divided into several sections:

- Setup:** Contains fields for Operator ID (82), Radio State (UP), and Alignment Metric (28.0). A red box highlights the BN Serial (S141T1212900202), Hostname (S154F1212600023), and Data VLAN (0) fields.
- Alignment Metric:** A large green gauge showing the current value of 28.0, with a maximum of 28.3.
- Location Fields:** Latitude (39.560001373291016), Longitude (-98.56300354003906), Tilt (0.1120000034570694), Height (0 m), and Azimuth (41.12799835205078).
- BN Connection History:** A table showing the last connection and disconnection times and reasons for the selected BN.

BN Serial	Last Connect Time	Last Disconnect Time	Last Disconnect Reason
S141T1212900202	an hour ago	an hour ago	radio-reset

Figure 10: Set RN Hostname and Data VLAN

Geography and Orientation Parameters

- Latitude: Geographical latitude of the RN in decimal notation.
- Longitude: Geographical longitude of the RN in decimal notation.
- Tilt: Vertical (elevation) angle of device installation as measured from the horizon (0 degrees).
- Height: Installed height above mean sea level (AMSL).
- Azimuth: Horizontal angle of device installation as measured clockwise from north.

Note: The latitude, longitude, and azimuth can manually be entered here or from the RN's Device page in TCS, but the Tilt, and Height, can only be configured from the RN's Web UI.

For 5 GHz RNs, the latitude and longitude are only necessary for an accurate Map View in TCS and the Height, Tilt, and Azimuth are optional.

However, for CBRS RNs, all five of these parameters are required. Remember, the Tilt and Height can only be configured from the RN's Web UI.

To modify a setting, make the change then click Submit Changes. For a 5GHz RN, configuration changes are immediately applied.

The screenshot shows the Tarana Web UI interface. On the left is a navigation menu with options: Dashboard, Interfaces, Setup (selected), Diagnostics, Upgrade, Reboot, and Snapshot. Below the menu is a system status section showing the date and time (January 17, 2022, 2:04 PM), System Uptime (an hour), Serial No (S154F1212600023), and SYS A3.R10.XXX.0.974.034.00. The main content area is titled 'Setup' and includes a 'Hostname' field with the value 'S154F1212600023'. Below this is a 'Radio State' field with the value 'UP' and a 'BN Serial' field with the value 'S141T1212900202'. A large green arc represents the 'Alignment Metric' at 28.0, with a maximum of 28.3. To the right of the arc are input fields for 'Latitude' (39.560001373291016), 'Longitude' (-98.56300354003906), 'Tilt' (0.1120000034570694), 'Height' (0 m), and 'Azimuth' (41.1279983205078). A 'SUBMIT CHANGES' button is located at the bottom right of the form. A table at the bottom shows the 'BN Connection History' with columns for BN Serial, Last Connect Time, Last Disconnect Time, and Last Disconnect Reason.

BN Serial	Last Connect Time	Last Disconnect Time	Last Disconnect Reason
S141T1212900202	an hour ago	an hour ago	radio-reset

Figure 11: Geography and Orientation Parameters

For CBRS models, after Submit Changes is clicked, an Installation Parameters pop-up will appear. Verify the installation parameters are correct, then enter your CPI ID and click Confirm.

Parameter	Value
Hostname	S154F1212600023
Data VLAN	0
Latitude	39.560001
Longitude	-98.563004
Tilt	0.112000
Height	2.00
Azimuth	41.13

Verify that the above information is correct and enter your CPI ID below

CPI ID

Note: For CBRS units, the GPS coordinates, tilt, height (AGL), and azimuth must be configured and verified by a CPI upon installation. Until this is done, the RN will be connected to the BN in restricted mode and will not pass data or be visible in TCS.

The RN's web UI should not be used for configuration changes once the initial deployment has been completed. Configuration settings in TCS will overwrite web UI settings. To avoid confusion or incorrect settings being applied, use TCS for configuration once the device is registered and connected to TCS.

TCS Confirmation

To verify the RN is accessible from the Tarana Cloud Suite (TCS), use an Internet connection external to the RN.

Step 1. Login to Tarana Cloud Suite (TCS) using the URL:
cloud.taranawireless.com

For the username and password, contact the TCS system administrator.

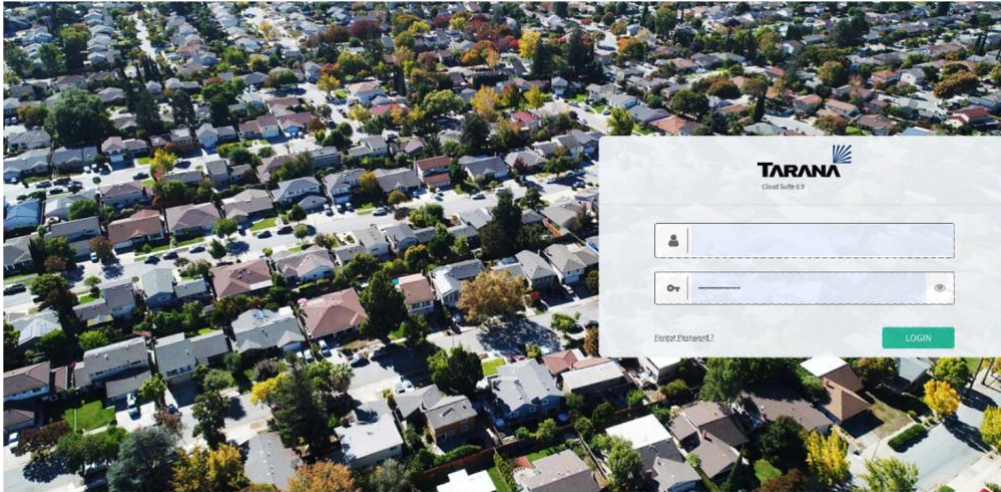

Step 2. From the left column, click on “DEVICES”.

Step 3. Verify that “RN” is selected from the RN/BN switch.

Step 4. Finally, verify the RN is online as indicated by its Serial Number being in green text.

Serial Number	Hostname	Software Version	Frequency Carrier 0 (MHz)	Frequency Carrier 1 (MHz)
S154F1213200008	RN-0008	0.974.008.00	3320	3360
Z19137136	RNF014	0.974.008.00	3360	
Z19137090	RNF018	0.974.008.00	3360	
Z19137105	RNF021	0.809.040.01	3320	
Z19207199	RNF023	0.974.008.00	3360	
Z19137063	RNF024	0.974.008.00	3360	

CBRS Steps in TCS

For CBRS installations, the CPI should edit their user profile in TCS to include the CPI ID and upload their CPI certificate.

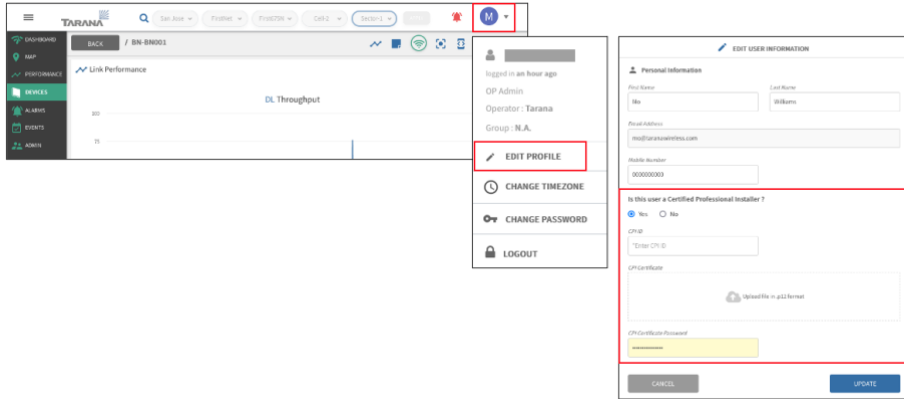

Note: The FCC OR-ID is assigned to customers by the Spectrum Access Service provider (Google or Federated Wireless).

The FCC OR-ID and SAS fields must be configured for CBRS installations. These parameters are under Network Configuration. Edit the Operator page to configure these parameters.

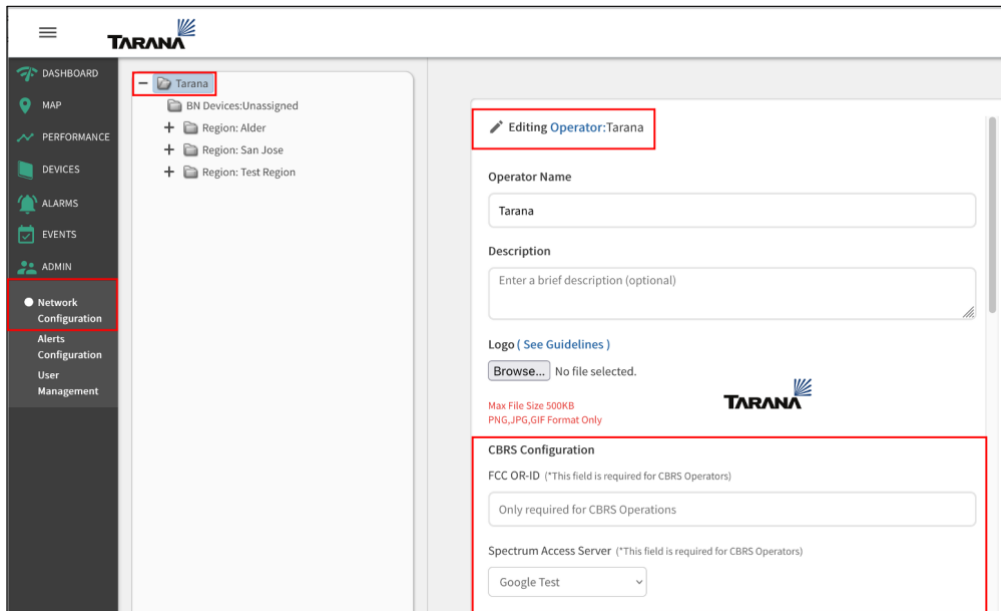

Supplier's Declaration of Conformity

Tarana Wireless Inc., as the grantee of this project (FCC ID: 2ABOF-G1-RN5ASI002 / Brand Name: Tarana / Model No.: G1RN5ASI002), we would like to declare that the RN device section categorized as computer peripheral has been evaluated, reference - Sporton report No.: FD201029001 and is in compliance with FCC Part 15 B rules. The final product shall consequently comply with the FCC rule applicable for SDoC Procedure.

Filing Type: Supplier's Declaration of Conformity

IC: 11717A-G1RN5ASI002

FCC ID: 2ABOF-G1-RN5ASI002

Equipment: Remote Node (RN)

Brand Name: Tarana

Model Name: G1RN5ASI002

HVIN: RN5ASI002

Marketing Name: G1-RN5ASI002

PMN: G1 Product Line

FCC Grantee contact person information.

Applicant: Tarana Wireless, Inc

Manufacturer: Tarana Wireless, Inc.

590 Alder Drive, Milpitas, CA 95035

URL: [http://: Taranawireless.com](http://Taranawireless.com)

Standard: FCC 47 CFR FCC Part 15 Subpart B Class B

ISED ICES-003 Issue 6 Class B



Signature _____

Name: Christopher Saleem

Title: Regulatory Compliance Manager

Email: Certifications@taranawireless.com

Phone: 408.351.4085

www.taranawireless.com

590 Alder Drive, Milpitas, California 95035

408.351.4085

Tarana Wireless Proprietary and Confidential

Supplier's Declaration of Conformity

Tarana Wireless Inc., as the grantee of this project (FCC ID: 2ABOF-G1-RN3ASI001 / Brand Name: Tarana / Model No.: G1RN3ASI001), we would like to declare that the RN device section categorized as computer peripheral has been evaluated, reference - Sporton report No.: FD210405001, and is in compliance with FCC Part 15 B rules. The final product shall consequently comply with the FCC rule applicable for SDoC Procedure.

Filing Type: Supplier's Declaration of Conformity
FCC ID: 2ABOF-G1-RN3ASI001
Equipment: Remote Node (RN)
Brand Name: Tarana
Model Name: G1RN3ASI001

FCC Grantee contact person information.
Applicant: Tarana Wireless, Inc
Manufacturer: Tarana Wireless, Inc.
590 Alder Drive, Milpitas, CA 95035
URL: [http://: Taranawireless.com](http://Taranawireless.com)

Standard: FCC 47 CFR FCC Part 15 Subpart B Class B



Signature _____
Name: Christopher Saleem
Title: Regulatory Compliance Manager
Email: Certifications@taranawireless.com
Phone: 408.351.4085

www.taranawireless.com

590 Alder Drive, Milpitas, California 95035

408.351.4085

Regulatory Information

This device supports UNII-1 and UNII-3 in the FCC (USA); supports UNII-3 only in ISED (Canada).

Compliance	
Safety	<ul style="list-style-type: none">IEC 62368-1:2014 (Second Edition), Rev. February 26, 2014 and EN 62368-1: 2014, Second Edition, + A11-2017, Audio/video, information and communication technology equipmentIEC 60950-22:2016 for use in conjunction with IEC 60950-1:2005, AMD1:2009, AMD2:2013IEC 60529, Edition 2.2 - 2013-08IEC/EN 60950-22
Radio Approvals	<ul style="list-style-type: none">FCC Part 15 Subpart E §15.407RSS-247FCC Part 96
EMI and susceptibility	<ul style="list-style-type: none">ISED ICES-003 Issue 6 Class BFCC 47 CFR FCC Part 15 Subpart B Class BCAN ICES-3(B)/NMB-3(B)

Deployment in the US – FCC Statement

This product must be professionally installed.

This device complies with FCC Part 15 rules. Operation is subject to the following two conditions: (1) this device may not cause harmful interference, and (2) this device must accept any interference received, including interference that may cause undesired operation.

Modifications not expressly approved by Tarana Wireless Inc. could void the user's authority to operate the equipment.

NOTE: This equipment has been tested and found to comply with the FCC and ISED limits for a digital device and the FCC limits for a Class B digital device, pursuant to part 15 of the FCC Rules. These limits are designed to provide reasonable protection against harmful interference when the equipment is operated in a commercial environment.

This equipment generates, uses and can radiate radio frequency energy and, if not installed and used in accordance with the instruction manual, may cause harmful interference to radio communications. However, there is no guarantee that interference will not occur in a particular installation. If this equipment does cause harmful interference to radio or television reception, which can be determined by turning the equipment off and on, the user is encouraged to try to correct the interference by one or more of the following measures:

- Reorient or relocate the receiving antenna.
- Increase the separation between the equipment and receiver.
- Connect the equipment into an outlet on a circuit different from that to which the receiver is connected.
- Consult the dealer or an experienced radio/TV technician for help.

This device complies with FCC RF exposure limits. This equipment should be installed and operated with a minimum distance of 63 cm (24.8 in.) between the radiator and user. This transmitter must not be co-located or operating in conjunction with any other antenna or transmitter.

Deployment in Canada — Industry Canada Statements

This product must be professionally installed.

This Class B Digital apparatus meets all the requirements of ICES-003.

To satisfy IC RF exposure requirements for RF transmitting devices, the following distances should be maintained between the antenna of this device and persons during device operation: 63 cm.

This device has been designed to ensure that radio frequency emissions are maintained within the band of operation under all normal operating conditions listed in this manual.

This device complies with Industry Canada RSS standard(s). Operation is subject to the following two conditions:

This device may not cause interference, and

This device must accept any interference, including interference that may cause undesired operation of the device.

Le produit final doit être installé par un professionnel

Cet appareil numérique de la classe B est conforme à la norme NMB-003 du Canada.

IC avertissements d'exposition RF Pour satisfaire les exigences d'IC en ce qui a trait aux expositions aux RF pour RF dispositifs de transmission, les distances suivantes doit être maintenue entre l'antenne de ce dispositif et des personnes pendant le fonctionnement du dispositif: 63 cm.

Ce dispositif a été conçu pour veiller à ce que les émissions de radiofréquences sont maintenus dans la bande de fonctionnement dans toutes les conditions normales de fonctionnement figurant dans ce manuel.

Cet appareil est conforme la norme d'Industrie Canada RSS (s). Son fonctionnement est soumis aux deux conditions suivantes:

Cet appareil ne peut pas causer d'interférences, et.

Cet appareil doit accepter toute interférence, y compris les interférences qui peuvent causer un mauvais fonctionnement de l'appareil.

Resolution 680: Brazil

Regulamento Anatel sobre equipamentos de Radiocomunicação de Radiação Restrita (Resolução n° 680): “Este equipamento não tem direito à proteção contra interferência prejudicial e não pode causar interferência em sistemas devidamente autorizados – Para maiores informações, consulte o site da Anatel <https://www.gov.br/anatel/pt-br/>

USA CBRS Band Category B Device

The Tarana RN requires installation by a CPI (Certified Professional Installer) as defined in Section 96.39 and 96.45 of FCC part 96 requirements. The RN is Classified as a Category B CBSD (Citizen Broadband Radio Device), which requires the following information be recorded and uploaded as part of the CPI process per section 96.45.

All CSBDs	Category B Devices
<ul style="list-style-type: none">• Geographic location• Antenna height AGL (m)• CBSD class (Category A or B)• Requested authorization status (PAL or GAA)• FCC ID• Call sign (PALs only)• User contact info• Air interference technology• Serial #• Sensing capability (if supported)	<ul style="list-style-type: none">• Limited to Outdoor operation• Antenna gain• Antenna Beam-width• Antenna Azimuth• Antenna Down tile angle

Warranty

Tarana warrants that commencing from the date of shipment to you (and in case of resale to you by a Tarana partner, commencing not more than 90 days after our original shipment), and continuing for a period of twelve (12) months, the hardware will be free from defects in material and workmanship under normal use. This limited warranty is not transferrable. Your sole and exclusive remedy and our entire liability under this limited warranty will be, at our option, shipment of a replacement or a refund of the purchase price, if you notify us of the defect within the warranty period and return the hardware to us freight and insurance prepaid. Parts used in replacement may be new or reconditioned. Our obligations are conditioned upon the return of affected hardware in accordance with our then-current standard Return Material Authorization (RMA) procedures. This limited warranty does not cover (a) damage resulting from (i) use in other than the wireless transport applications defined in our product documentation; (ii) use not in accord with applicable spectrum regulations; (iii) handling, testing, installation, operation, maintenance, service, repair, alteration, modification, or adjustment outside of practices and conditions defined in our product documentation; (iv) other general misuse, accident, liquid intrusion, or neglect; (v) unauthorized radio connection to equipment not supplied by us; (vi) illegal or unauthorized alteration of software or firmware; (vii) acts of nature (such as lightning) or performance failure of other equipment (including electrical transients and over/under voltage); (b) scratches, discoloration, or other cosmetic damage to surfaces that do not affect operation; (c) normal and customary wear and tear; and (d) any product where serial number, revision level, part number, date code, warranty data, tamper-proof seals, or quality assurance decals have been removed or altered.

DISCLAIMER: Except as specified above, all express or implied conditions, representations, and warranties including, without limitation, any implied warranty or condition of merchantability, fitness for a particular purpose, non-infringement, satisfactory quality, non-interference, accuracy of informational content, or arising from a course of dealing, law, usage, or trade practice, are hereby excluded to the extent allowed by applicable law and are expressly disclaimed by us. To the extent an implied warranty cannot be excluded, such warranty is limited in duration to the express warranty period. This disclaimer and exclusion will apply even if the express warranty set forth above fails of its essential purpose.

Tarana products are not designed, intended, or certified for use in communication systems for, or relating to (a) weapons or weapons systems, (b) nuclear facilities, (c) air traffic control or other mass transportation systems, (d) life support systems or other medical devices, (e) applications where electrical sparks could trigger explosions or fires, or (f) any other systems, devices or applications in which the failure of the product to operate as intended may lead to death, bodily injury, or catastrophic property damage (each an “Unauthorized Use”). Many of such Unauthorized Uses would require specific industry certification which has not been sought or obtained for the Tarana products.

LIABILITY. Tarana will not be liable for any special, incidental, indirect, or consequential damages (including lost profits or property damage) arising out of or relating to the sale of the goods to you or your possession, installation, use, operation or repair of the goods, even if the goods are nonconforming, defective, infringing, delayed, or not delivered, and even if Tarana has been advised of the possibility of such damages. You agree to indemnify and hold us harmless from any claims, suits, demands and causes of action arising out of or relating to your possession, installation, use, operation or repair of the goods. Notwithstanding any other provisions of this document, in no event will our total liability in connection with or relating to the goods exceed the amount you have paid us for the goods.