

VHLP6-18-2WH/B

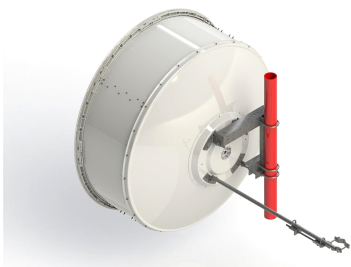

1.8 m | 6 ft ValuLine® High Performance Low Profile Antenna, single-polarized, 17.700–19.700 GHz, PBR220, white antenna, flexible woven polymer gray radome without flash, standard pack—one-piece reflector

Product Classification

Brand	ValuLine®
Product Type	Microwave antenna

General Specifications

Antenna Type	VHLP - ValuLine® High Performance Low Profile Antenna, single-polarized
Diameter, nominal	1.8 m 6 ft
Packing	Standard pack
Radome Color	Gray
Radome Material	Polymer
Reflector Construction	One-piece reflector
Antenna Input	PBR220
Antenna Color	White
Antenna Type	VHLP - ValuLine® High Performance Low Profile Antenna, single-polarized
Diameter, nominal	1.8 m 6 ft
Flash Included	No
Polarization	Single

Electrical Specifications

Operating Frequency Band	17.700 – 19.700 GHz
Beamwidth, Horizontal	0.7 °
Beamwidth, Vertical	0.7 °
Cross Polarization Discrimination (XPD)	30 dB
Electrical Compliance	Brazil Anatel Class 3 Canada SRSP 317.8 Part A ETSI 302 217 Class 3 US FCC Part 101A
Front-to-Back Ratio	76 dB
Gain, Low Band	47.5 dBi
Gain, Mid Band	48.0 dBi
Gain, Top Band	48.5 dBi
Operating Frequency Band	17.700 – 19.700 GHz
Radiation Pattern Envelope Reference (RPE)	7063B
Return Loss	17.7 dB

VSWR 1.30

Mechanical Specifications

Fine Azimuth Adjustment	±15°
Fine Elevation Adjustment	±5°
Mounting Pipe Diameter	115 mm–120 mm 4.5 in–4.7 in
Net Weight	86 kg 190 lb
Side Struts, Included	1
Side Struts, Optional	1 inboard
Wind Velocity Operational	180 km/h 112 mph
Wind Velocity Survival Rating	250 km/h 155 mph

Wind Forces At Wind Velocity Survival Rating

Angle α for MT Max	-120 °
Axial Force (FA)	10670 N 2399 lbf
Side Force (FS)	5286 N 1188 lbf
Twisting Moment (MT)	4752 N-m 3505 ft lb
Weight with 1/2 in (12 mm) Radial Ice	234 kg 516 lb
Zcg with 1/2 in (12 mm) Radial Ice	543 mm 21 in
Zcg without Ice	363 mm 14 in

Wind Forces At Wind Velocity Survival Rating Image

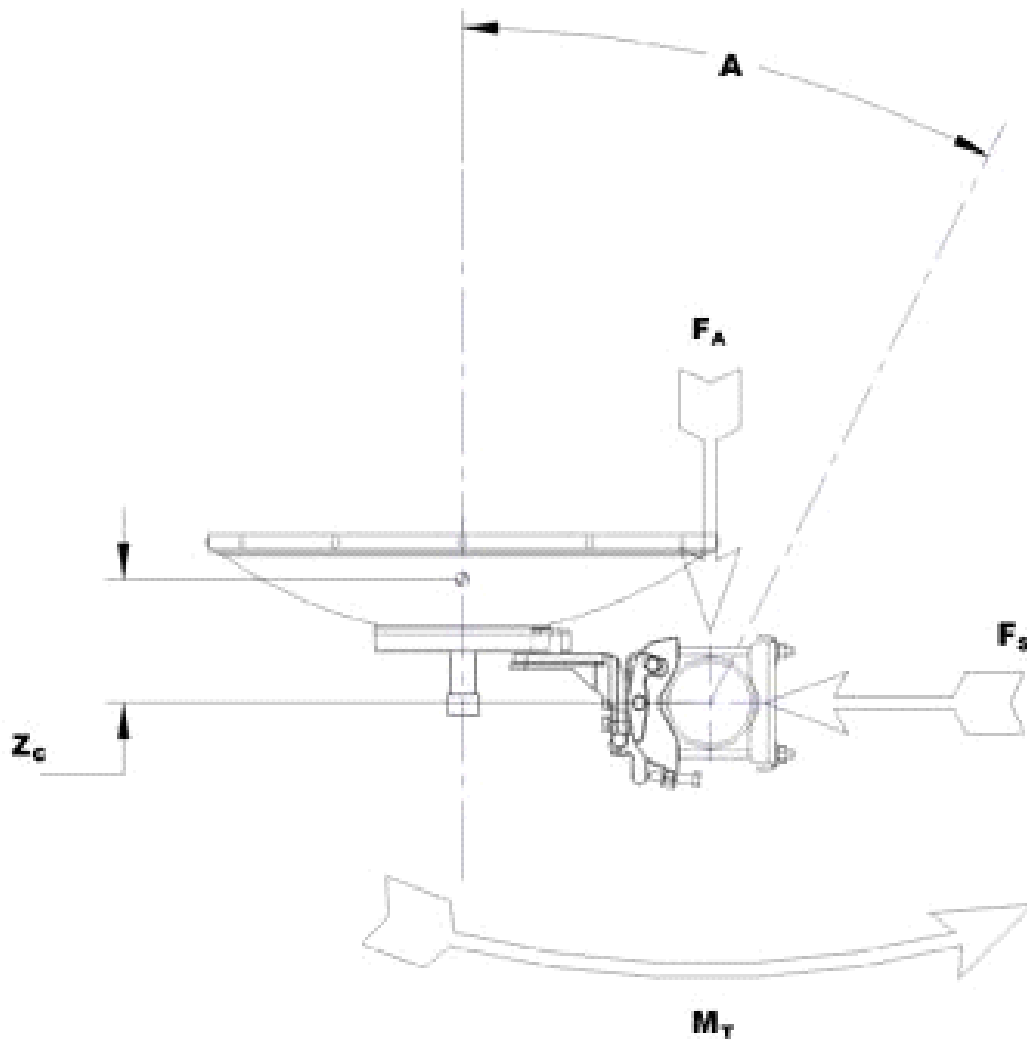

Packed Dimensions

Gross Weight, Packed Antenna	127.0 kg 280.0 lb
Height	211.0 cm 83.1 in
Length	190.0 cm 74.8 in
Volume	1.8 m ³
Width	45.0 cm 17.7 in

Antenna Dimensions And Mounting Information

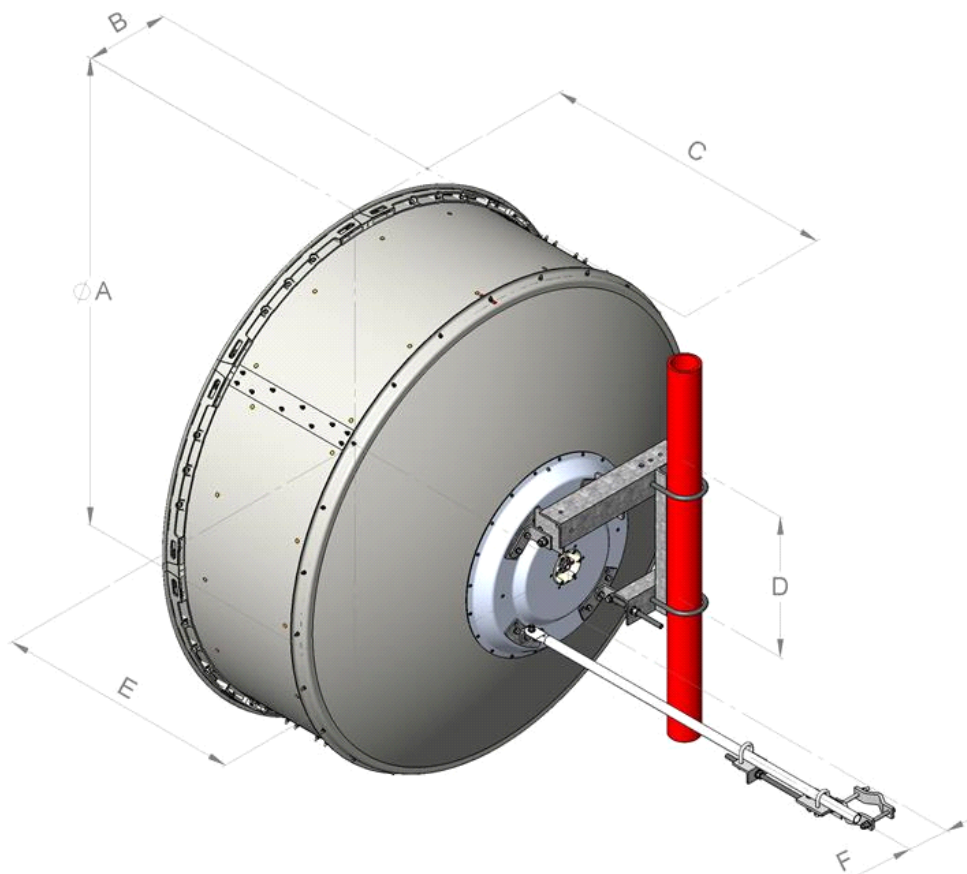

Dimensions in inches (mm)						
Antenna size, ft (m)	A	B	C	D	E	F
6 (1.8)	74.8 (1899)	13.4 (340)	47.5 (1206)	22.4 (570)	39.4 (1001)	6.9 (174)

Regulatory Compliance/Certifications

Agency

ISO 9001:2008

Classification

Designed, manufactured and/or distributed under this quality management system

* Footnotes

Axial Force (FA)	Maximum forces exerted on a supporting structure as a result of wind from the most critical direction for this parameter. The individual maximums specified may not occur simultaneously. All forces are referenced to the mounting pipe.
Cross Polarization Discrimination (XPD)	The difference between the peak of the co-polarized main beam and the maximum cross-polarized signal over an angle twice the 3 dB beamwidth of the co-polarized main beam.
Front-to-Back Ratio	Denotes highest radiation relative to the main beam, at $180^\circ \pm 40^\circ$, across the band. Production antennas do not exceed rated values by more than 2 dB unless stated otherwise.
Gain, Mid Band	For a given frequency band, gain is primarily a function of antenna size. The gain of Andrew antennas is determined by either gain by comparison or by computer integration of the measured antenna patterns.
Operating Frequency Band	Bands correspond with CCIR recommendations or common allocations used throughout the world. Other ranges can be accommodated on special order.
Packing	Andrew standard packing is suitable for export. Antennas are shipped as standard in totally recyclable cardboard or wire-bound crates (dependent on product). For your convenience, Andrew offers heavy duty export packing options.
Radiation Pattern Envelope Reference (RPE)	Radiation patterns define an antenna's ability to discriminate against unwanted signals. Under still dry conditions, production antennas will not have any peak exceeding the current RPE by more than 3dB, maintaining an angular accuracy of $\pm 1^\circ$ throughout
Return Loss	The figure that indicates the proportion of radio waves incident upon the antenna that are rejected as a ratio of those that are accepted.
Side Force (FS)	Maximum side force exerted on the mounting pipe as a result of wind from the most critical direction for this parameter. The individual maximums specified may not occur simultaneously. All forces are referenced to the mounting pipe.
Twisting Moment (MT)	Maximum forces exerted on a supporting structure as a result of wind from the most critical direction for this parameter. The individual maximums specified may not occur simultaneously. All forces are referenced to the mounting pipe.
VSWR	Maximum; is the guaranteed Peak Voltage-Standing-Wave-Ratio within the operating band.
Wind Velocity Operational	The wind speed where the antenna deflection is equal to or less than 0.1 degrees. In the case of ValuLine antennas, it is defined as a maximum deflection of 0.3 x the 3 dB beam width of the antenna.
Wind Velocity Survival Rating	The maximum wind speed the antenna, including mounts and radomes, where applicable, will withstand without permanent deformation. Realignment may be required. This wind speed is applicable to antenna with the specified amount of radial ice.